



ARKIVVERKET
RIKSARKIVET

Samdok

samla samfunnsdokumentasjon

Noark 5 tjenestegrensesnitt



DELPROSJEKT

Arkiv i e-forvaltning

Norsk Arkivråds høstseminar
23. oktober 2013

Hans Fredrik Berg, Riksarkivet

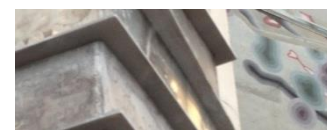

Innhold

- **SAMDOK**
- Systemarkitektur
- Noark 5 arkivstruktur
- Noark 5 tjenestegrensesnitt

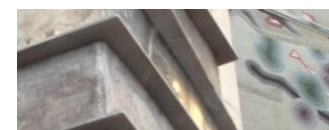

Samla samfunnsdokumentasjon

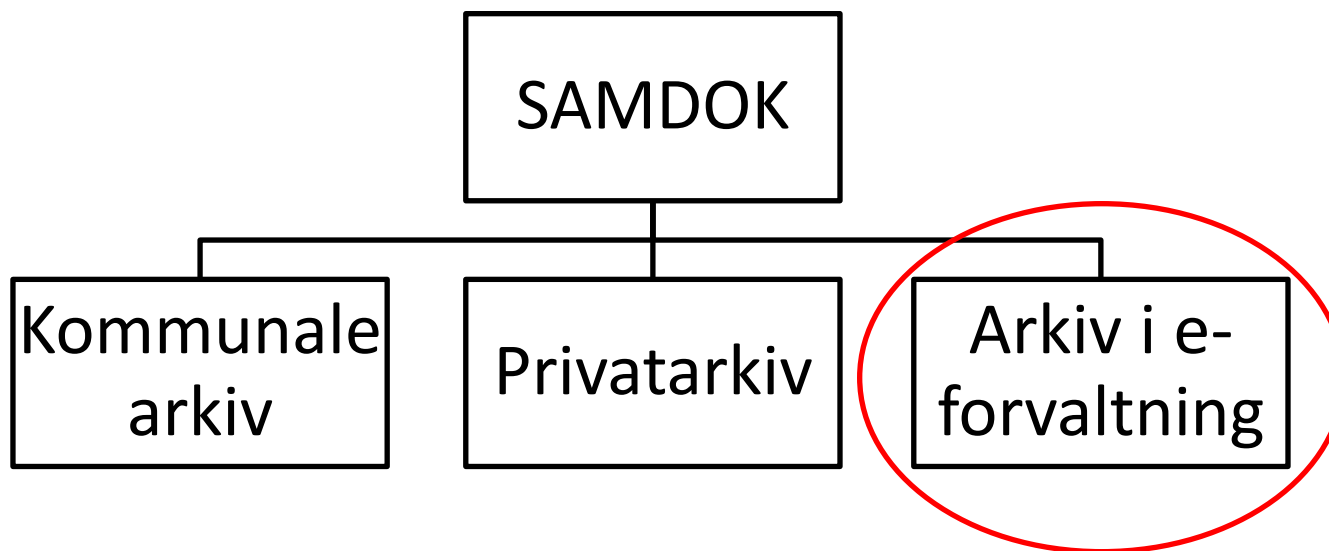

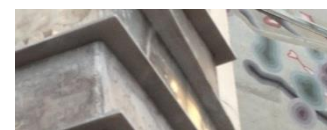

Innhold

- SAMDOK
- **Systemarkitektur**
- Noark 5 arkivstruktur
- Noark 5 tjenestegrensesnitt



Frittstående, komplett applikasjon

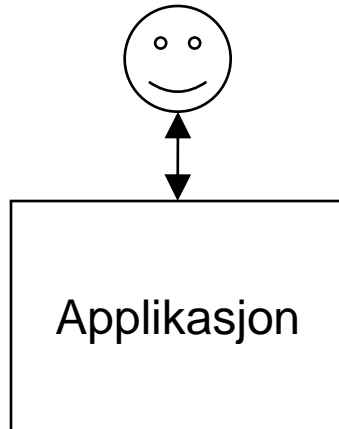



med databasehåndteringssystem

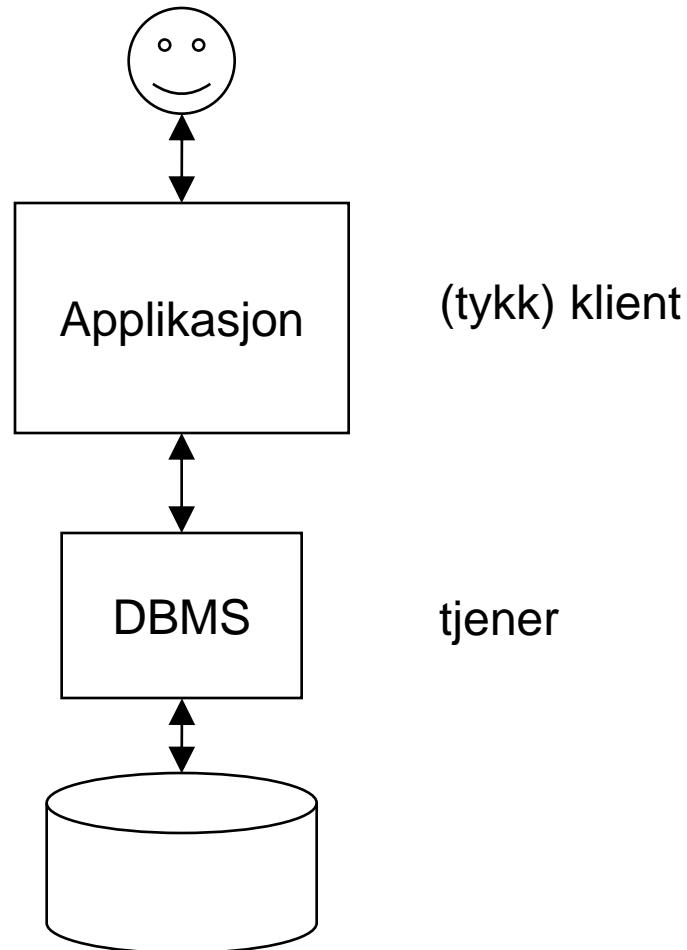



på en annen maskin

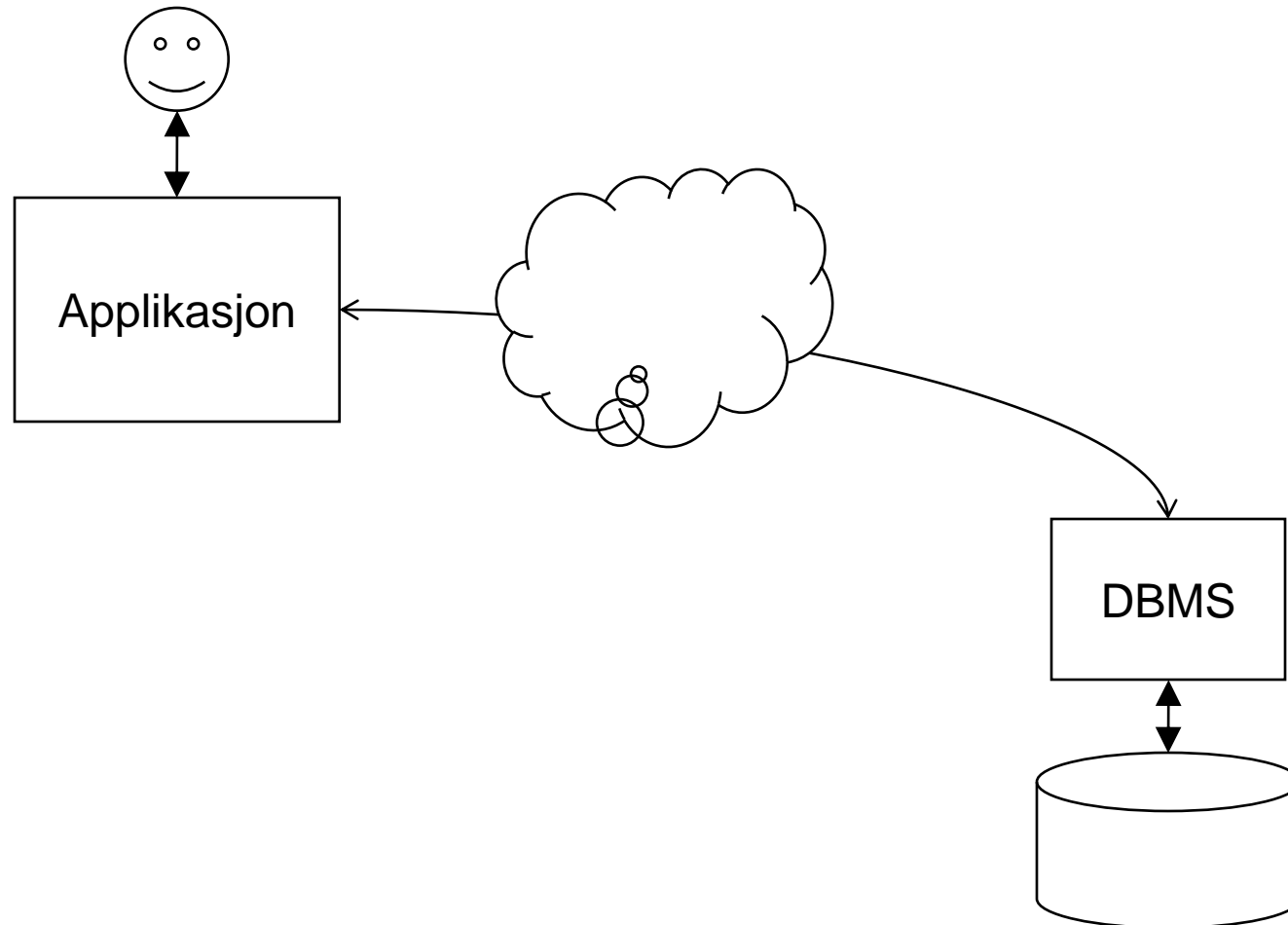



applikasjonen delt mellom klient og tjener

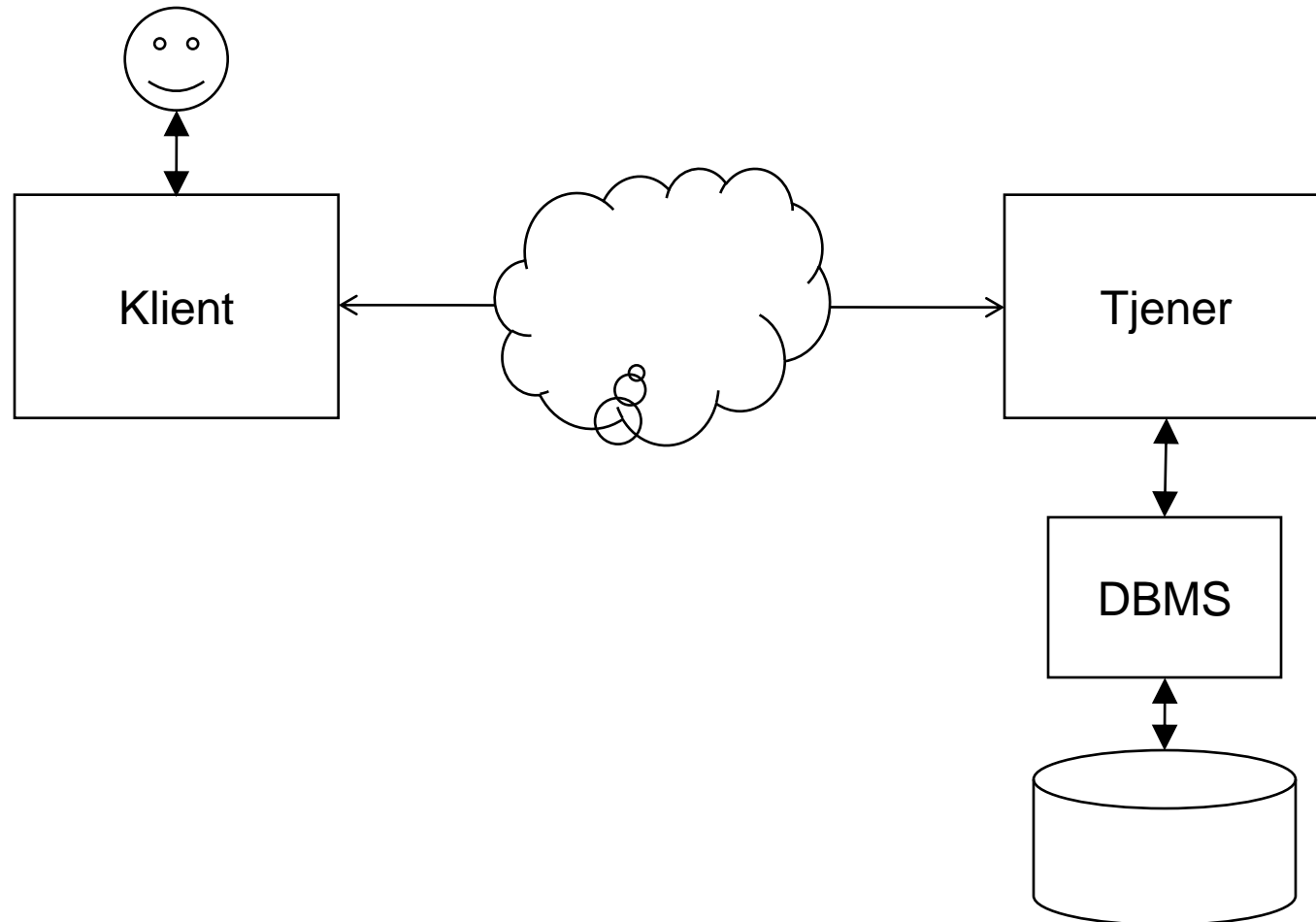



Web

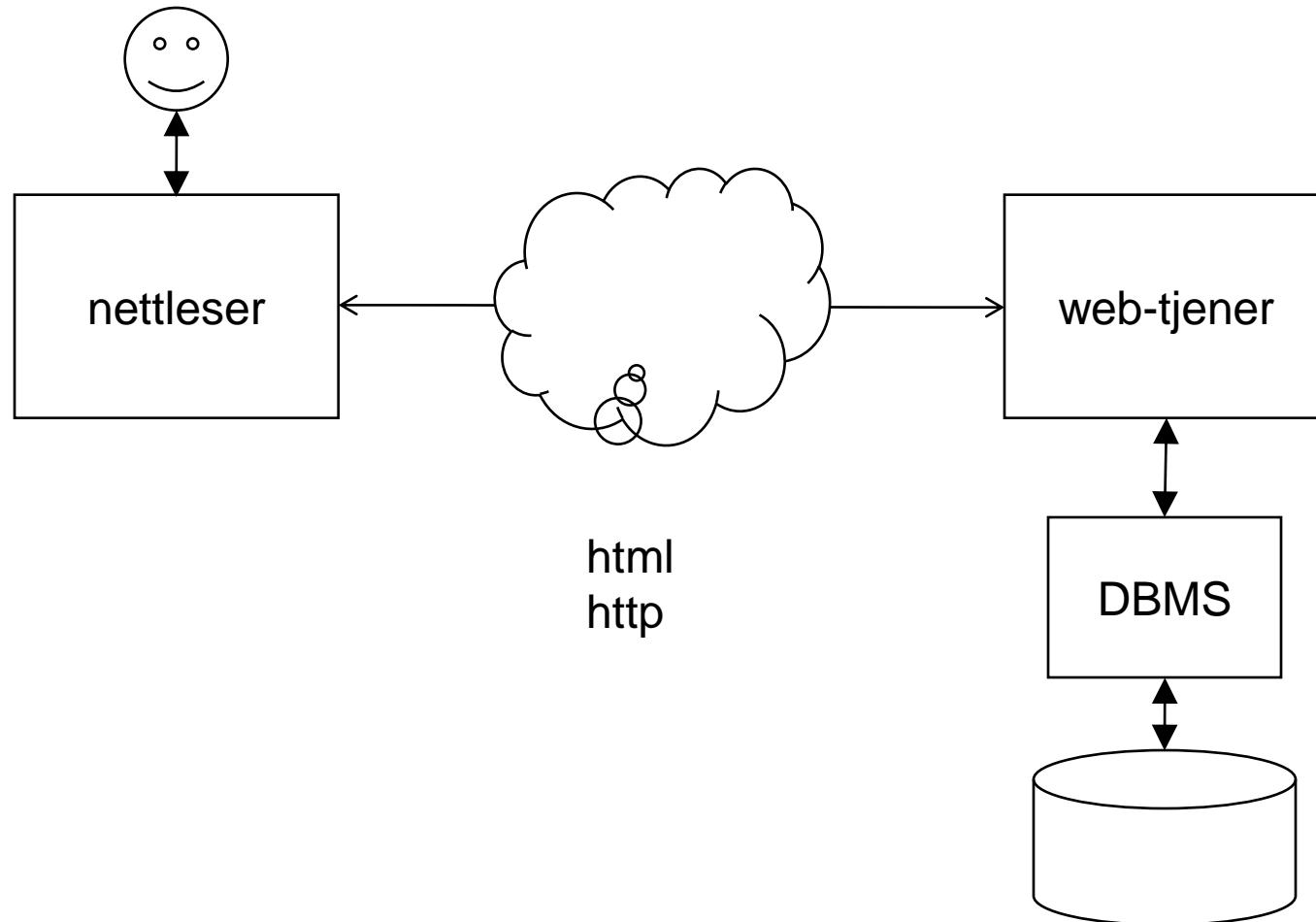



Web services

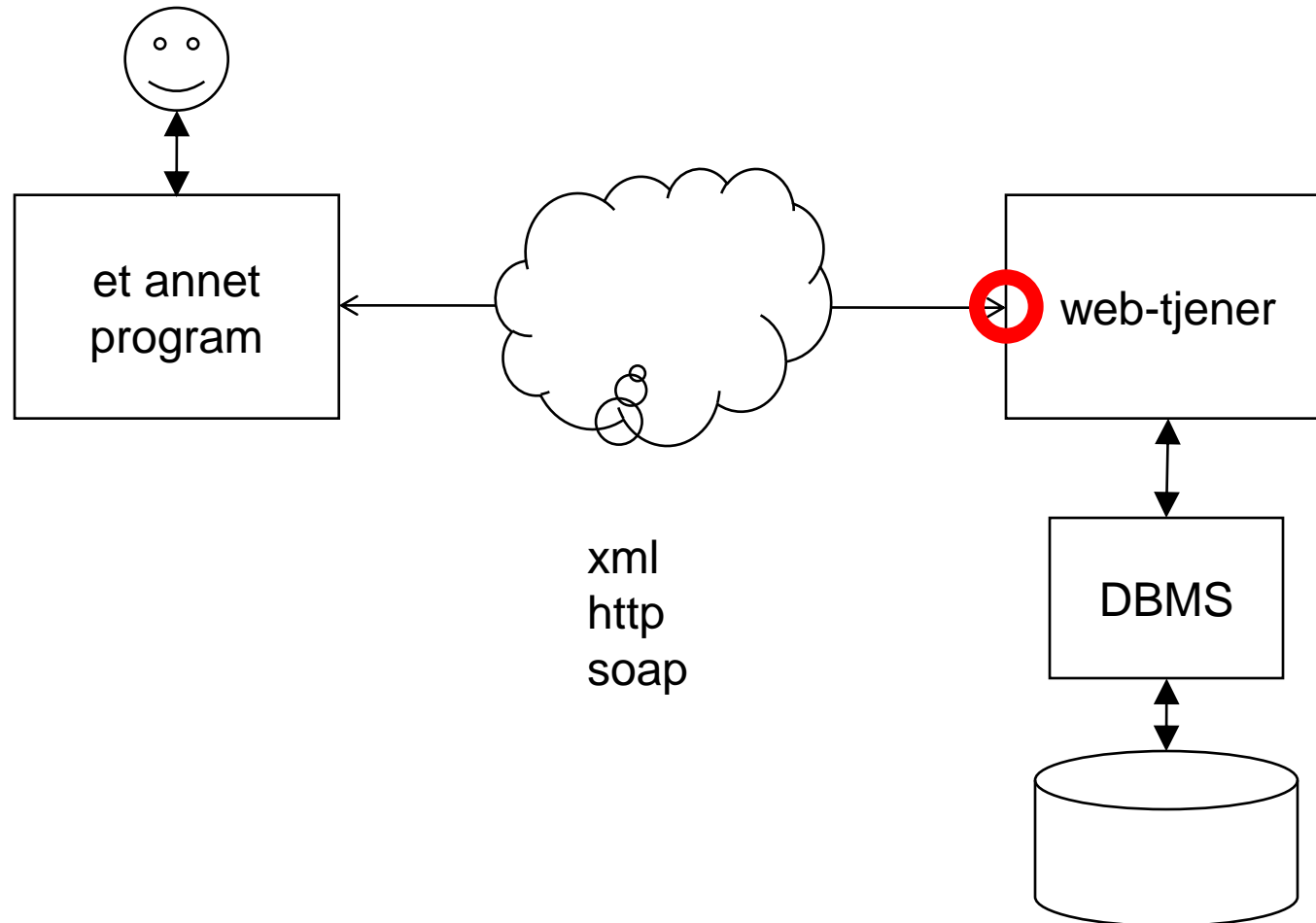



Tjenesteorientert arkitektur

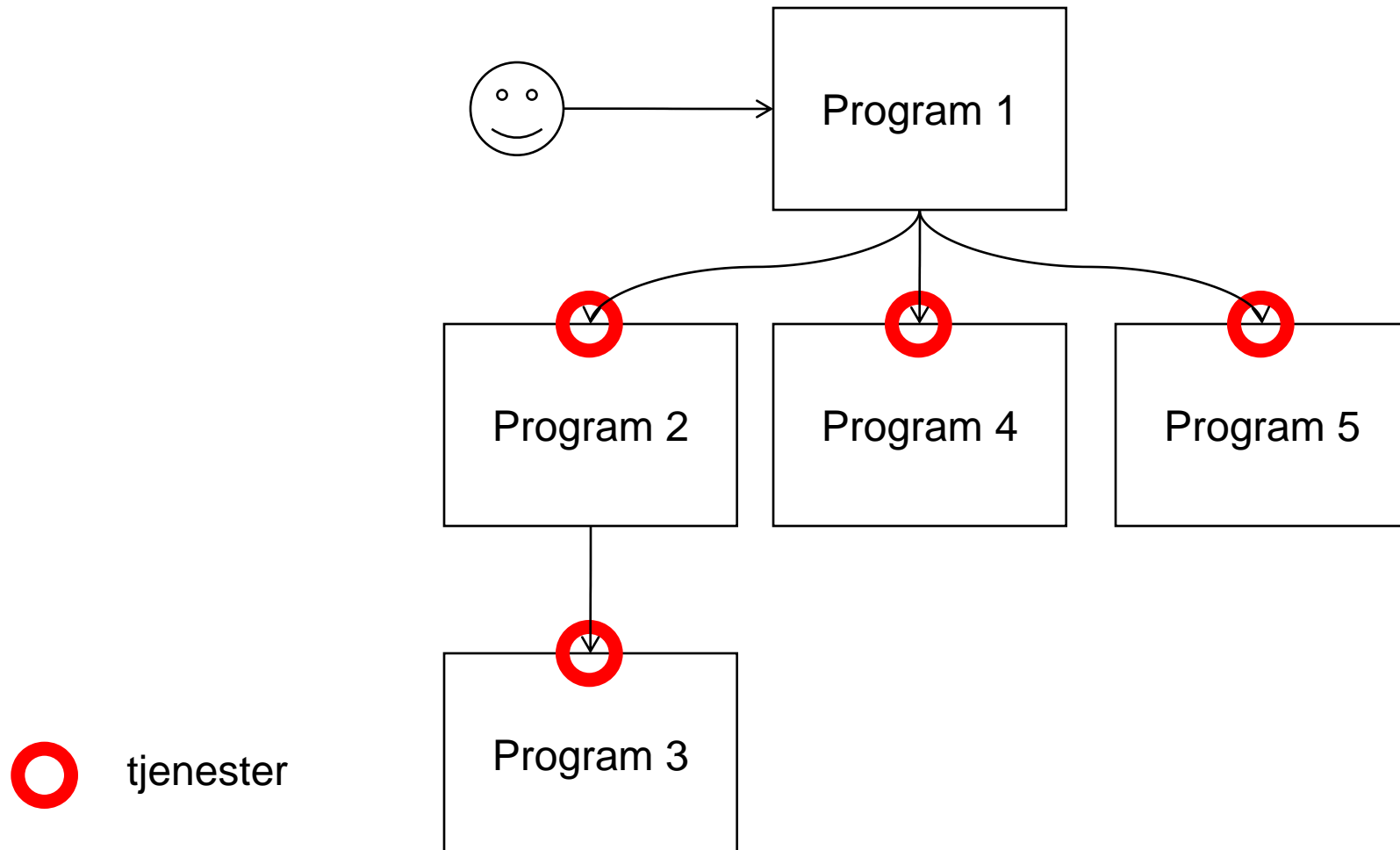



Tjenestebuss

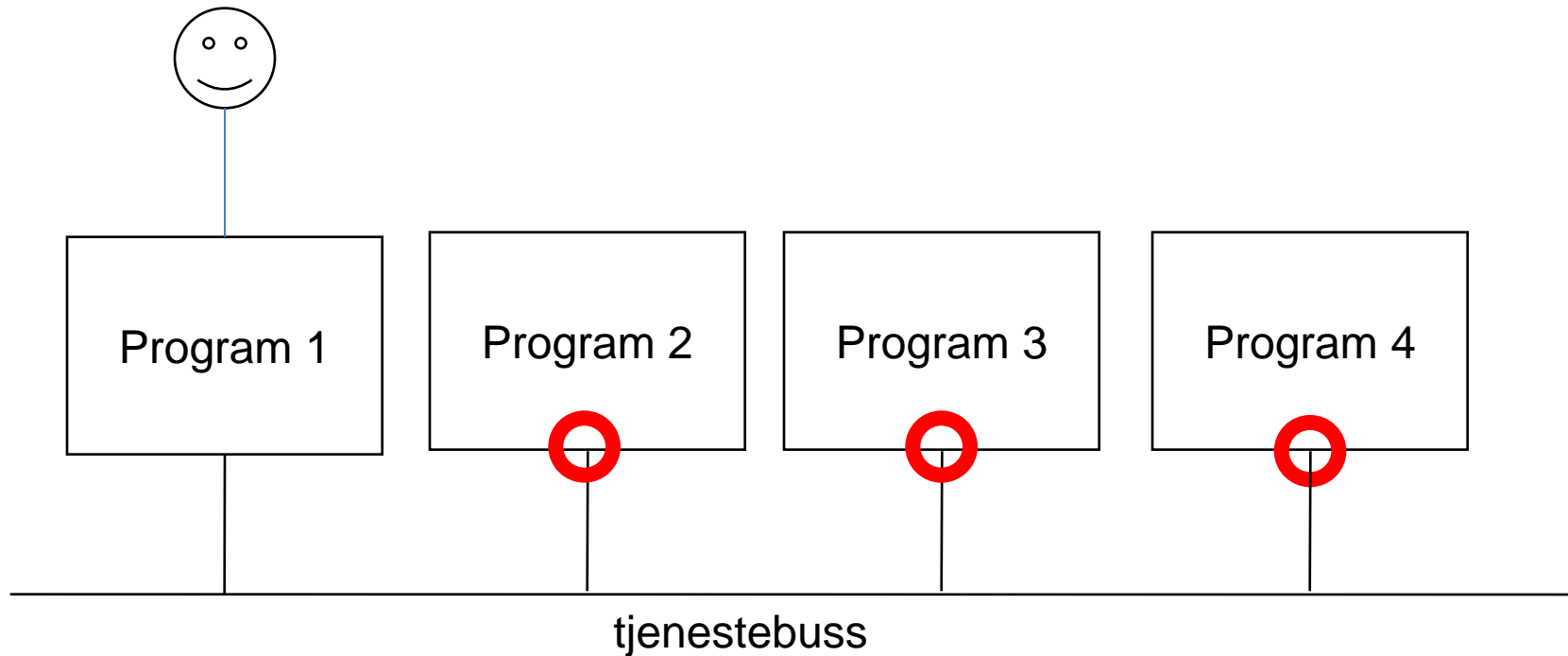

 tjenester



”Tjenestenettverk”

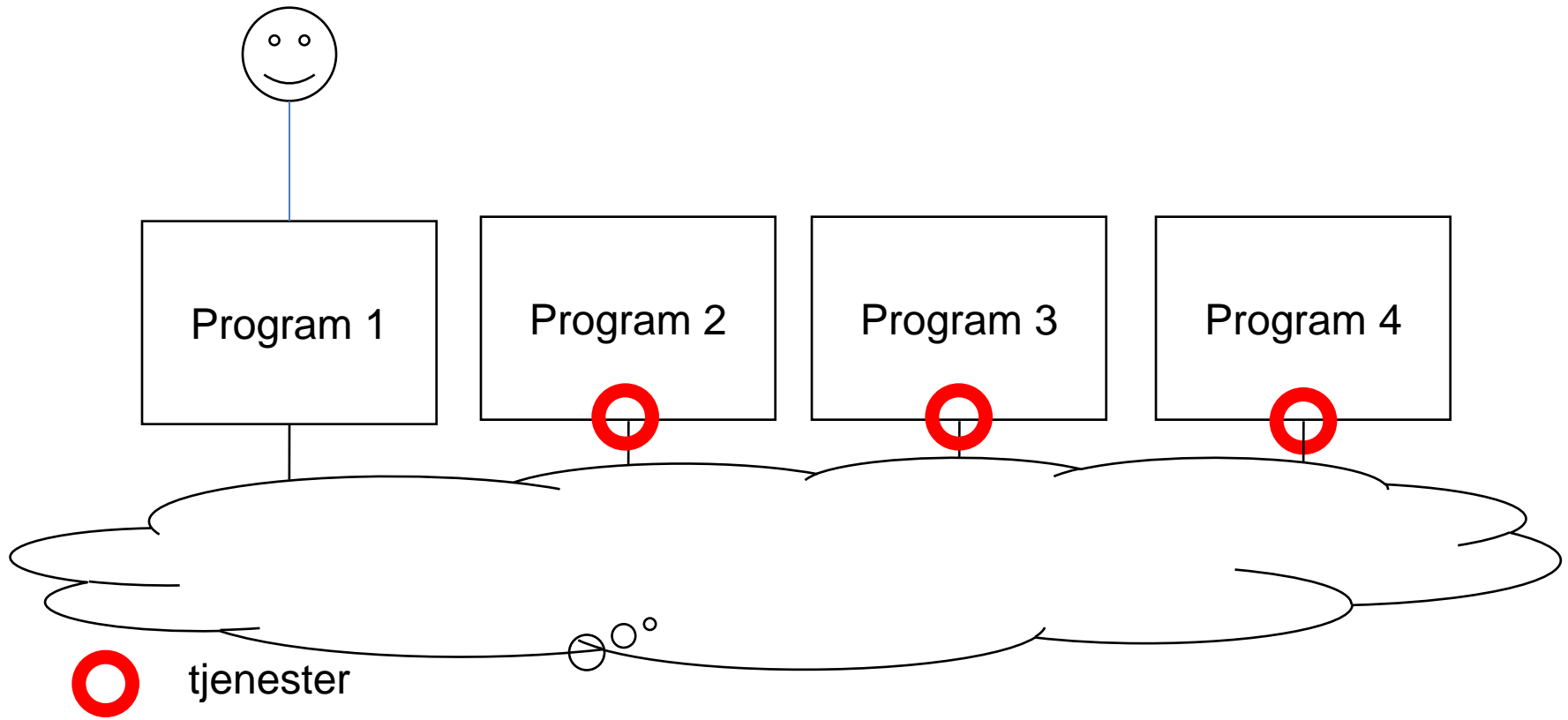



Noark 5 WS

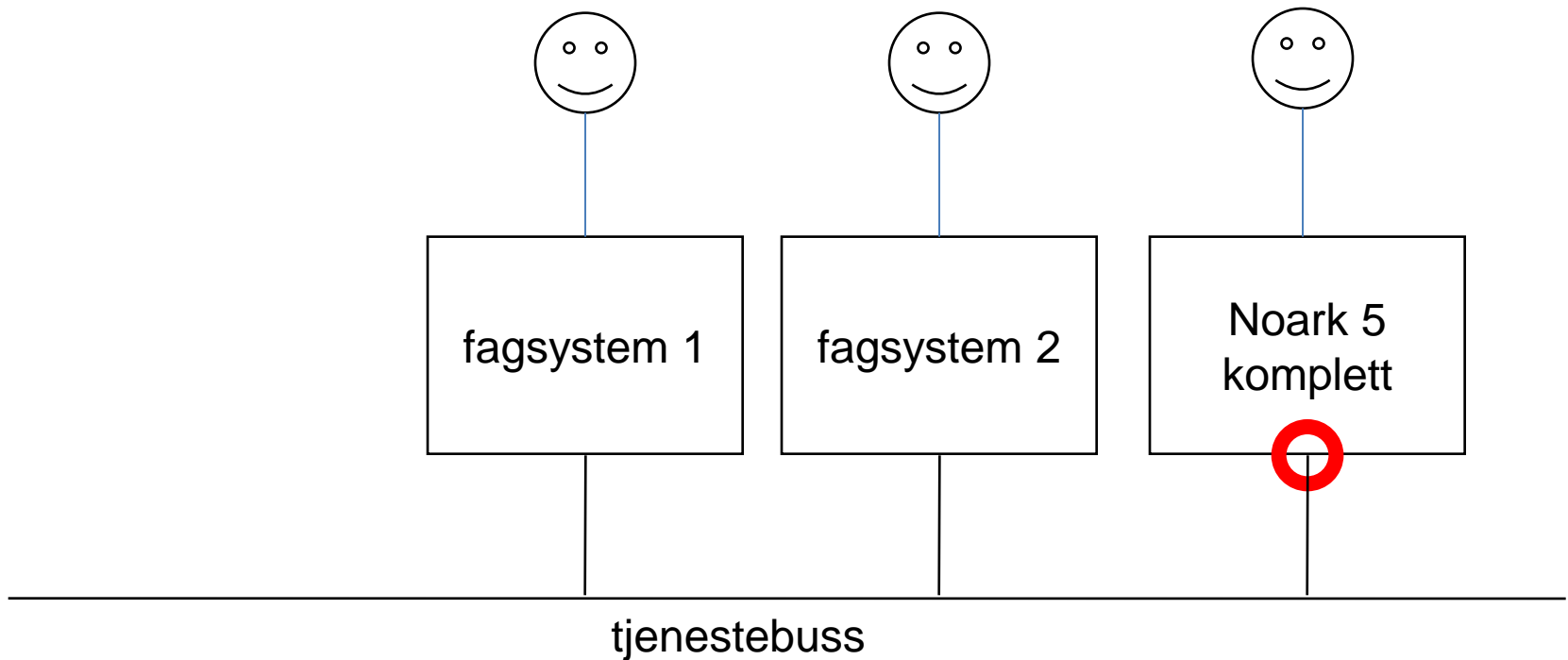

 tjenester



Noark 5 WS

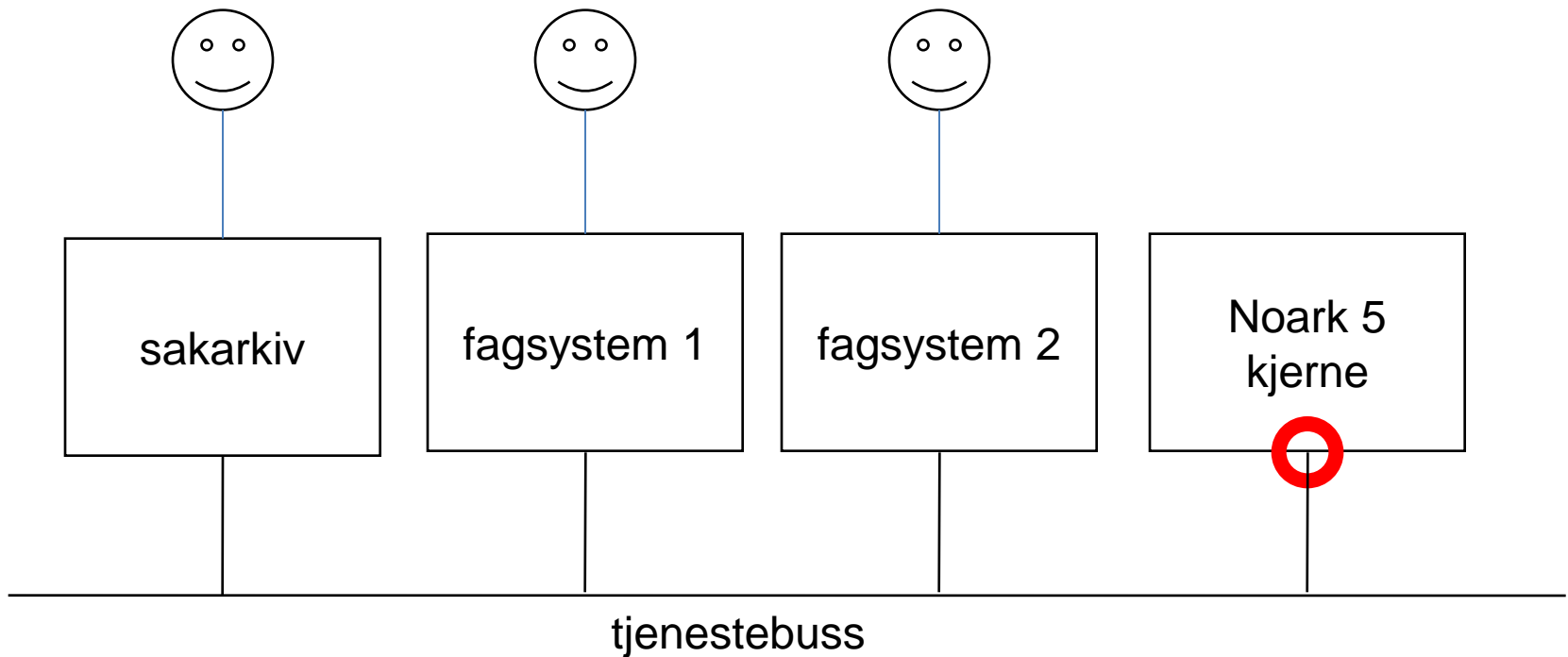

 tjenester



Innhold

- SAMDOK
- Systemarkitektur
- **Noark 5 arkivstruktur**
- Noark 5 tjenestegrensesnitt



Noark 5 arkivstruktur

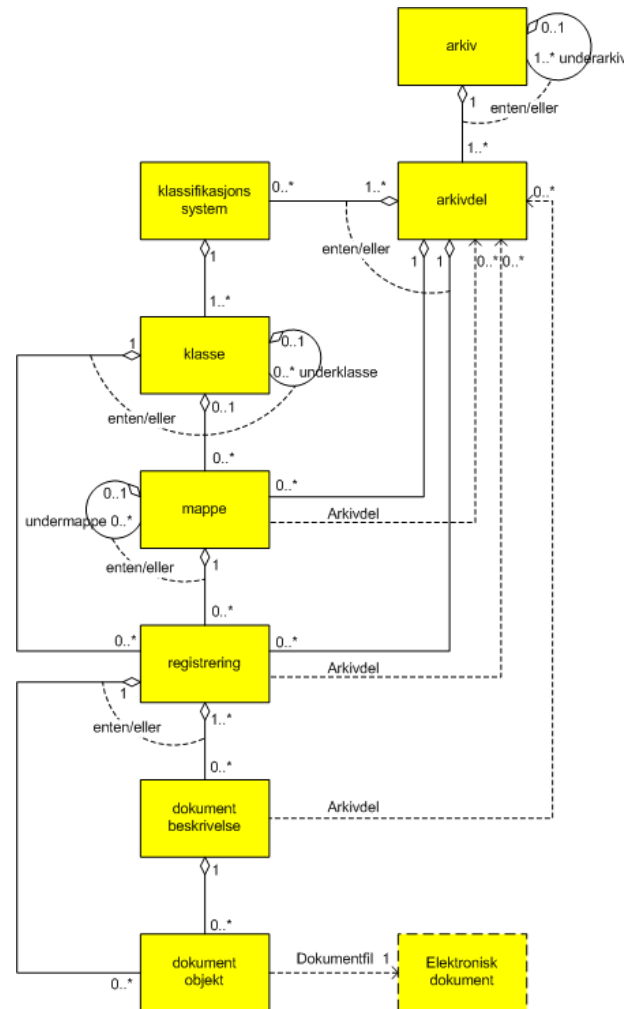

Totalt 44
objekttyper



Innhold

- SAMDOK
- Systemarkitektur
- Noark 5 arkivstruktur
- **Noark 5 tjenestegrensesnitt**
 - UML informasjonsmodell
 - CRUD: Create, Read, Update, Delete
 - sammensatte tjenester

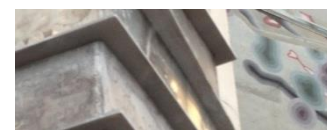

UML informasjonsmodell

- Det skal etableres plattformuavhengig informasjonsmodell i UML for arkivstrukturen
 - fra denne kan det genereres plattformspeifikke modeller som xsd, wsdl, rdf, rest, med mer
- Det skal defineres enkle CRUD-tjenester for alle objekter i informasjonsmodellen
- Det skal produseres xsd og wsdl fra UML-modellen

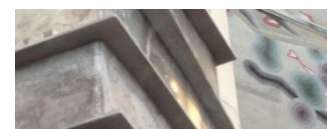

CRUD

Enkle tjenester for å opprette, lese, oppdatere og slette

- nyRegistrering (mappeSystemID, nyRegistrering) -> systemID
 - Parameteren systemID identifiserer hvilken mappe (eller klasse eller arkivdel) registreringen skal tilhøre. Tjenesten returnerer systemID til den nye registreringen
- hentRegistrering (systemID) -> registrering
- oppdaterRegistrering (systemID, registrering)
- slettRegistrering (systemID)

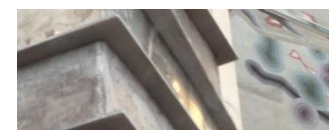

CRUD med betingelser

- slettRegistrering(systemID)
 - Krav 6.1.27 - Det skal ikke være mulig å slette en Registrering med status Arkivert, Journalført eller Ekspedert.
- oppdaterDokumentbeskrivelse(systemID, dokumentbeskrivelse)
 - Krav 6.1.45 - Det skal ikke være mulig å endre status "Dokumentet er ferdigstilt"
 - Krav 6.1.46 - For Dokumentbeskrivelse med status "Dokumentet er ferdigstilt" skal det være tillatt å endre tittel på hoveddokument og vedlegg

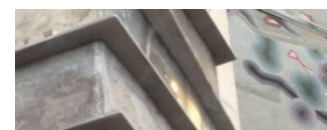

Sammensatte tjenester

- flyttRegistreringTilMappe
(registreringSystemID,mappeSystemID)
- avskrivJournalpostMedNy
(avskrivendeJournalpostSystemID,
avskrevetJournalpostSystemID)